

TCP220

Compact PCI IP Carrier

Version 1.0

User Manual

Issue 1.3

September 2006

TEWS TECHNOLOGIES GmbH

Am Bahnhof 7
25469 Halstenbek, Germany
www.tews.com

Phone: +49-(0)4101-4058-0
Fax: +49-(0)4101-4058-19
e-mail: info@tews.com

TEWS TECHNOLOGIES LLC

9190 Double Diamond Parkway,
Suite 127, Reno, NV 89521, USA
www.tews.com

Phone: +1 (775) 850 5830
Fax: +1 (775) 201 0347
e-mail: usasales@tews.com

TCP220-10

Compact PCI Carrier for 4 IndustryPack® modules

This document contains information, which is proprietary to TEWS TECHNOLOGIES GmbH. Any reproduction without written permission is forbidden.

TEWS TECHNOLOGIES GmbH has made any effort to ensure that this manual is accurate and complete. However TEWS TECHNOLOGIES GmbH reserves the right to change the product described in this document at any time without notice.

TEWS TECHNOLOGIES GmbH is not liable for any damage arising out of the application or use of the device described herein.

Style Conventions

Hexadecimal characters are specified with prefix 0x, i.e. 0x029E (that means hexadecimal value 029E).

For signals on hardware products, an 'Active Low' is represented by the signal name with # following, i.e. IP_RESET#.

Access terms are described as:

W	Write Only
R	Read Only
R/W	Read/Write
R/C	Read/Clear
R/S	Read/Set

©2002-2006 by TEWS TECHNOLOGIES GmbH

IndustryPack is a registered trademark of SBS Technologies, Inc

Issue	Description	Date
1.0	Initial Issue	October 2002
1.1	General Revision	December 2002
1.2	Correction Figure " PCI to Local Byte lane swapping"	November 2003
1.3	New address TEWS LLC	September 2006

Table of Contents

1	PRODUCT DESCRIPTION	6
2	TECHNICAL SPECIFICATION	7
3	PCI INTERFACE	8
	3.1 PCI Configuration (CFG) Registers	9
	3.1.1 PCI Header.....	9
	3.1.2 PCI Base Address Initialization.....	10
	3.1.2.1 I/O Base Address Implementation.....	11
	3.1.2.2 Memory Base Address Implementation.....	11
	3.1.2.3 Expansion ROM Base Address Implementation.....	12
	3.2 Local Configuration Register	13
	3.3 Target Configuration EEPROM	14
	3.4 Endian Conventions	15
	3.4.1 Intel CPU View.....	16
	3.4.2 PowerPC CPU View.....	17
	3.4.3 Intel CPU View with TCP220 switched to Big Endian.....	18
	3.4.4 PowerPC CPU View with TCP220 switched to Big Endian.....	19
	3.5 Big / Little Endian Mode setting	20
4	IP INTERFACE	21
	4.1 PCI9030 Local Space Assignment	21
	4.1.1 Local Space 0 Address Map.....	22
	4.1.2 Local Space 1 Address Map.....	22
	4.1.3 Local Space 2 Address Map.....	23
	4.1.4 Local Space 3 Address Map.....	24
	4.2 IP Interface Register	24
	4.2.1 Revision ID Register.....	24
	4.2.2 IP Control Register.....	25
	4.2.3 IP Reset Register.....	29
	4.2.4 IP Status Register.....	29
	4.3 IP Interrupts	31
5	IP STROBE SIGNAL	32
6	INSTALLATION OF INDUSTRYPACKS	33
7	INDICATORS	34
	7.1 ACK- and Power- LEDs.....	34
	7.2 Fuses and Filters.....	34
8	PIN ASSIGNMENT	35
	8.1 IP Connectors.....	35
	8.2 Compact PCI J4.....	36
	8.3 Compact PCI J5.....	37

Table of Figures

FIGURE 1-1 : BLOCK DIAGRAM.....	6
FIGURE 2-1 : TECHNICAL SPECIFICATION.....	7
FIGURE 3-1 : PCI CONFIGURATION REGISTER MAP	9
FIGURE 3-2 : LOCAL CONFIGURATION REGISTERS.....	13
FIGURE 3-3 : PCI9030 CONFIGURATION EEPROM CONTENT	14
FIGURE 3-4 : INTEL CPU VIEW.....	16
FIGURE 3-5 : POWERPC CPU VIEW	17
FIGURE 3-6 : INTEL CPU VIEW WITH TCP220 SWITCHED TO BIG ENDIAN.....	18
FIGURE 3-7 : POWERPC CPU VIEW WITH TCP220 SWITCHED TO BIG ENDIAN	19
FIGURE 3-8 : PCI TO LOCAL BYTE LANE SWAPPING	20
FIGURE 4-1 : PCI9030 LOCAL SPACE ASSIGNMENT.....	21
FIGURE 4-2 : LOCAL SPACE 0 ADDRESS MAP	22
FIGURE 4-3 : LOCAL SPACE 1 ADDRESS MAP (IP A-D ID, INT, I/O SPACE).....	22
FIGURE 4-4 : LOCAL SPACE 2 ADDRESS MAP (IP A-D MEMORY SPACE 16 BIT).....	23
FIGURE 4-5 : LOCAL SPACE 3 ADDRESS MAP (IP A-D MEMORY SPACE 8 BIT).....	24
FIGURE 4-6 : REVISION ID REGISTER (PCI BASE ADDRESS 2 + 0X00).....	24
FIGURE 4-7 : IP A CONTROL REGISTER (PCI BASE ADDRESS 2 + 0X02).....	25
FIGURE 4-8 : IP B CONTROL REGISTER (PCI BASE ADDRESS 2 + 0X04).....	26
FIGURE 4-9 : IP C CONTROL REGISTER (PCI BASE ADDRESS 2 + 0X06)	27
FIGURE 4-10: IP D CONTROL REGISTER (PCI BASE ADDRESS 2 + 0X08)	28
FIGURE 4-11: IP RESET REGISTER (PCI BASE ADDRESS 2 + 0X0A)	29
FIGURE 4-12: IP STATUS REGISTER (PCI BASE ADDRESS 2 + 0X0C).....	31
FIGURE 5-1 : IP STROBE SIGNAL	32
FIGURE 6-1 : TCP220 FRONT VIEW.....	33
FIGURE 7-1 : IP ACK LED.....	34
FIGURE 7-2 : IP POWER LED.....	34
FIGURE 8-1 : IP J1 LOGIC INTERFACE PIN ASSIGNMENT.....	35
FIGURE 8-2 : COMPACT PCI J4.....	36
FIGURE 8-3 : COMPACT PCI J5.....	37

1 Product Description

The TCP220 is a standard 6U CompactPCI Carrier that provides back I/O for up to 4 single-size or two double-size IndustryPack (IP) modules. It is used to build modular, flexible and cost effective I/O solutions for applications in process control, medical systems, telecommunication and traffic control.

Access to all IP I/O lines is provided by a PICMG 2.4 R1.0 compliant I/O mapping via J4 and J5. Status indicators for IP access, +5V and +/-12V are provided in the front panel.

The TCP220 can operate with 3.3V and 5.0V PCI I/O signaling voltage.

All IP interrupt request lines are mapped to PCI INTA. For fast interrupt source detection, the TCP220 provides a special IP Interrupt Status Register.

The IP power lines are fuse protected by self healing fuses and RF filtered. The operating temperature range is -40°C to +85°C.

The TCP220 complies with the PICMG 2.0 Revision 3.0 CompactPCI specification.

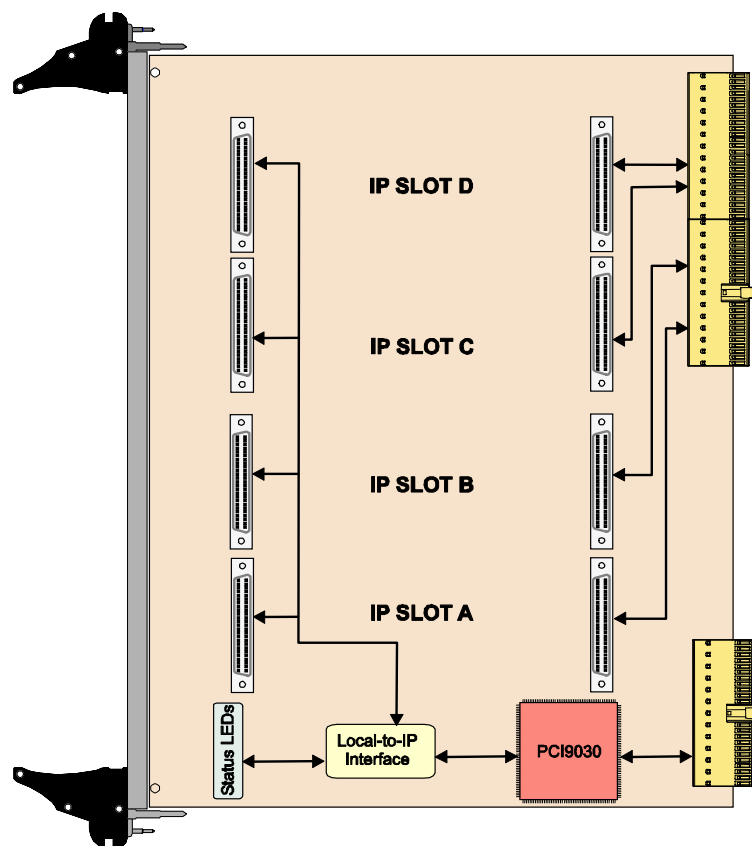

Figure 1-1 : Block Diagram

2 Technical Specification

Compact PCI Interface	Compact PCI 6U, conforming to PICMG 2.0 R3.0
PCI Interface	PCI 2.2 compliant interface, 33 MHz, 32 bit
PCI I/O Signaling Voltage	3.3V or 5.0V
IP Interface	According to IndustryPack specification ANSI / VITA 4-1995
IP Slots	Four single-size or two double-size with I/O
IP Access	8 / 16 bit 8 / 32 MHz, selectable per IP 8 Mbyte memory space per IP
Mapping of IP Interrupts	All IP interrupts are mapped to PCI INTA, Local Interrupt Status Register
I/O Access	PICMG 2.4 R1.0 compliant via J4 and J5
DMA	Not supported
32 Bit Access	Not supported
Status LEDs	ACK LED for each IP slot +5V Power LED for each IP slot +12V and -12V Power LED
Protection	Self healing fuses and RF-filtering on all IP power lines
Power Requirements without IP Modules	280 mA typical @ + 5V DC 1 mA typical @ + 12V DC 1 mA typical @ -12V DC Additional power is required by IP modules
Temperature Range	Operating - 40°C to + 85°C Storage - 40°C to + 85°C
MTBF	180636 h
Weight	305 g
Size	160 mm x 233.35 mm
Humidity	5 – 95 % non-condensing

Figure 2-1 : Technical Specification

3 PCI Interface

The TCP220 is accessible in the PCI Memory space.

The PCI9030 PCI Target Chip from PLX Technology is used as PCI target device for accessing the IP interface. A FPGA is used on the PCI9030 local bus to build the IP interface and provide IP interface control registers.

The PCI9030 provides four local spaces 0:3 that are used for the IP interface.

Basic PCI9030 register configuration is loaded from a serial EEPROM after power-up or board reset.

3.1 PCI Configuration (CFG) Registers

3.1.1 PCI Header

PCI CFG Register Address	Write '0' to all unused (Reserved) bits							PCI write able	Read after initialization write access (hex values)	
	31	24	23	16	15	8	7			0
0x00	Device ID				Vendor ID				N	20DC 1498
0x04	Status				Command				Y	0280 0003
0x08	Class Code					Revision ID		N	068000 00	
0x0C	BIST	Header Type		PCI Latency Timer		Cache line Size		Y[7:0]	00 00 00 00	
0x10	PCI Base Address 0 for Mem Mapped Configuration Registers							Y	FFFFFFF80	
0x14	PCI Base Address 1 for I/O Mapped Configuration Registers							Y	FFFFFFF81	
0x18	PCI Base Address 2 for Local Address Space 0							Y	FFFFFFF00	
0x1C	PCI Base Address 3 for Local Address Space 1							Y	FFFFFFC00	
0x20	PCI Base Address 4 for Local Address Space 2							Y	FE000000	
0x24	PCI Base Address 5 for Local Address Space 3							Y	FF000000	
0x28	Cardbus CIS Pointer							N	00000000	
0x2C	Subsystem ID			Subsystem Vendor ID				N	200A 1498	
0x30	PCI Base Address for Local Expansion ROM							Y	00000000	
0x34	Reserved					Next Cap P.		N	000000 40	
0x38	Reserved							N	00000000	
0x3C	Max_Lat	Min_Gnt		Interrupt Pin		Interrupt Line		Y[7:0]	00 00 01 00	
0x40	Power Management Capabilities			Next Cap Pointer		Capability ID		N	4801 48 01	
0x44	Data	PMCSR Bridge Support Extensions		Power Management Control/Status			Y	00 00 0000		
0x48	Reserved	Control/Status		Next_Cap Pointer		Capability ID		Y[23:16]	00 02 4C 06	
0x4C	VPD Address			Next_Cap Pointer		Capability ID		Y[31:16]	0000 00 03	
0x50	VPD Data Register							Y	00000000	

Figure 3-1 : PCI Configuration Register Map

3.1.2 PCI Base Address Initialization

PCI host bus-initialization software determines the required address space by an **initialization write access** (writing a value of all ones '1' to a PCI Base Address Register) and then reading back the value of the PCI Base Address Register. The PCI9030 (PCI Target chip) returns zero '0' in don't care address bits, specifying the required address space. The PCI software then maps the local address space into the PCI address space by programming the PCI Base Address Register.

After programming the required address spaces the user must set bit 0 (enables I/O accesses) and bit 1 (enables memory accesses) of the command register (Offset 0x04) to '1'.

3.1.2.1 I/O Base Address Implementation

1. Write a value of '1' to all bits of the PCI Base Address Registers 0 to 5.
2. Check that bit 0 of the register contains a value of '1' (PCI9030 needs an I/O address space).
3. Starting at bit location 2 of the PCI Base Address Register, search for the first bit set to a value of '1'. This bit is the binary size of the total contiguous block of I/O address space needed by the PCI9030.

For example, if bit 5 of the PCI Base Address Register is detected as the first bit set to '1', the PCI9030 is requesting a 32 byte block of I/O address space.

4. Write the start address of the requested I/O address space to the PCI Base Address Register.

The PCI Base Address 1 for I/O Mapped Configuration Registers (128 byte) is used by the TCP220 as I/O address space.

3.1.2.2 Memory Base Address Implementation

1. Write a value of '1' to all bits of the PCI Base Address Registers 0 to 5.
2. Check that bit 0 of the register contains a value of '0' (PCI9030 needs a memory address space).
3. Starting at bit location 4 of the PCI Base Address Register, search for the first bit set to a value of '1'. This bit is the binary size of the total contiguous block of memory address space needed by the PCI9030.

For example, if bit 15 of the PCI Base Address Register is detected as the first bit set to '1', the PCI9030 is requesting a 32 kilobyte block of memory address space.

4. Write the start address of the requested memory address block to the PCI Base Address Register. This memory address region must not conflict with any other memory space utilized within the system. In addition, it must comply with the definition contained in bits 1 and 2 of this register.

The PCI Base Address 0 for Memory Mapped Configuration Registers (128 byte) and the PCI Base Addresses 2 to 5 for Local Address Space 0 to 3 are used by the TCP220 as memory address space.

3.1.2.3 Expansion ROM Base Address Implementation

5. Write a value of '1' to bits 11 through 31 of PCI Base Address Local Expansion ROM Register.
6. Starting at bit location 11 of the PCI Base Address Local Expansion ROM Register, search upward for the first bit set to a value of '1'. This bit is the binary size of the total contiguous block of memory address space needed by the PCI9030.

For example, if bit 16 of the PCI Base Address Local Expansion ROM Register is detected as the first bit set, the device is requesting a 64 kilobyte block of memory address space.

7. Write the start address of the requested memory address block to the PCI Base Address Local Expansion ROM Register. This memory address region must not conflict with any other memory space utilized within the system.

The Expansion ROM is not used by the TCP220.

For further information please refer to the PCI9030 manual which is also part of the TCP220 Engineering Documentation.

3.2 Local Configuration Register

After reset, the Local Configuration Registers (LCRs) are loaded from the on board EEPROM. The LCRs are accessible in the PCI Base Address 0 Memory Mapped or in the PCI Base Address 1 I/O Mapped Configuration Registers.

Do not change the value of these registers because these values are hardware dependent.

PCI (Offset from Local Base Address)	Register	Value	Description
0x00	Local Address Space 0 Range	0x0FFFFFF0	IP Interface Register (256 byte)
0x04	Local Address Space 1 Range	0x0FFC00	IP A-D ID-, INT-, I/O-Space (1kByte)
0x08	Local Address Space 2 Range	0x0E00000	IP A-D MEM Space (16 bit) (32Mbyte)
0x0C	Local Address Space 3 Range	0x0F00000	IP A-D MEM Space (8 bit) (16Mbyte)
0x10	Local Exp. ROM Range	0x0000000	Not used
0x14	Local Re-map Register Space 0	0x0800001	Enabled
0x18	Local Re-map Register Space 1	0x0400001	Enabled
0x1C	Local Re-map Register Space 2	0x0000001	Enabled
0x20	Local Re-map Register Space 3	0x0200001	Enabled
0x24	Local Re-map Register ROM	0x0000000	Not used
0x28	Local Address Space 0 Descriptor	0xD44160A0	Timing local Space 0
0x2C	Local Address Space 1 Descriptor	0x144120A2	Timing local Space 1
0x30	Local Address Space 2 Descriptor	0x144120A2	Timing local Space 2
0x34	Local Address Space 3 Descriptor	0x140120A2	Timing local Space 3
0x38	Local Exp. ROM Descriptor	0x0000000	Not used
0x3C	Chip Select 0 Base Address	0x0800081	CS for local Space 0
0x40	Chip Select 1 Base Address	0x0400201	CS for local Space 1
0x44	Chip Select 2 Base Address	0x0100001	CS for local Space 2
0x48	Chip Select 3 Base Address	0x0280001	CS for local Space 3
0x4C	Interrupt Control/Status	0x0000041	Interrupt Configuration
0x4E	EEPROM Write Protect Boundary	0x0000000	No write protection
0x50	Miscellaneous Control Register	0x007A400	Retry Delay = max
0x54	General Purpose I/O Control	0x02249252	GPI/O2=CS2# GPI/O3=CS3#
0x70	Hidden 1 Power Management data select	0x0000000	Not used
0x74	Hidden 2 Power Management data scale	0x0000000	Not used

Figure 3-2 : Local Configuration Registers

3.3 Target Configuration EEPROM

After reset, the PCI9030 starts to load the configuration sequence from the on board EEPROM.

This EEPROM contains the following configuration data.

- From 0x00 to 0x27 : PCI – Configuration
- From 0x28 to 0x87 : Local – Configuration

EEPROM Address	0x00	0x02	0x04	0x06	0x08	0x0A	0x0C	0x0E
0x00	0x20DC	0x1498	0x0280	0x0000	0x0680	0x0000	0x200A	0x1498
0x10	0x0000	0x0040	0x0000	0x0100	0x4801	0x0001	0x0000	0x0000
0x20	0x0000	0x4C06	0x0000	0x0003	0x0FFF	0xFF00	0x0FFF	0xFC00
0x30	0x0E00	0x0000	0x0F00	0x0000	0x0000	0x0000	0x0800	0x0001
0x40	0x0400	0x0001	0x0000	0x0001	0x0200	0x0001	0x0000	0x0000
0x50	0xD441	0x60A0	0x1441	0x20A2	0x1441	0x20A2	0x1401	0x20A2
0x60	0x0000	0x0000	0x0800	0x0081	0x0400	0x0201	0x0100	0x0001
0x70	0x0280	0x0001	0x0000	0x0041	0x007A	0x4000	0x0224	0x9252
0x80	0x0000	0x0000	0x0000	0x0000	0xFFFF	0xFFFF	0xFFFF	0xFFFF
0x90	0xFFFF	0xFFFF	0xFFFF	0xFFFF	0xFFFF	0xFFFF	0xFFFF	0xFFFF
0xA0	0xFFFF	0xFFFF	0xFFFF	0xFFFF	0xFFFF	0xFFFF	0xFFFF	0xFFFF
0xB0	0xFFFF	0xFFFF	0xFFFF	0xFFFF	0xFFFF	0xFFFF	0xFFFF	0xFFFF
0xC0	0xFFFF	0xFFFF	0xFFFF	0xFFFF	0xFFFF	0xFFFF	0xFFFF	0xFFFF
0xD0	0xFFFF	0xFFFF	0xFFFF	0xFFFF	0xFFFF	0xFFFF	0xFFFF	0xFFFF
0xE0	0xFFFF	0xFFFF	0xFFFF	0xFFFF	0xFFFF	0xFFFF	0xFFFF	0xFFFF
0xF0	0xFFFF	0xFFFF	0xFFFF	0xFFFF	0xFFFF	0xFFFF	0xFFFF	0xFFFF

Figure 3-3 : PCI9030 Configuration EEPROM Content

3.4 Endian Conventions

This chapter tries to illuminate the mixed use of Big Endian and Little Endian convention in one system. The major difference between Big Endian and Little Endian are swapped byte lanes. The byte lanes for 16 bit and 32 bit data busses with Big Endian and Little Endian are shown below:

Little Endian convention on a 16 bit Data Bus:

Byte Lane	Byte 1	Byte 0
Data Line	D15 : D8	D7 : D0 (LSB)

Big Endian convention on a 16 bit Data Bus:

Byte Lane	Byte 0	Byte 1
Data Line	D15 : D8	D7 : D0 (LSB)

Little Endian convention on a 32 bit Data Bus:

Byte Lane	Byte 3	Byte 2	Byte 1	Byte 0
Data Line	D31 : D24	D23 : D16	D15 : D8	D7 : D0 (LSB)

Big Endian convention on a 32 bit Data Bus:

Byte Lane	Byte 0	Byte 1	Byte 2	Byte 3
Data Line	D31 : D24	D23 : D16	D15 : D8	D7 : D0 (LSB)

The PCI Bus and all Intel CPUs work in Little Endian mode. VMEbus, PowerPC and 68K CPUs work in Big Endian mode. Most IP modules, which are common in VMEbus systems, also use Big Endian byte ordering.

The TCP220 works in Little Endian mode by default, but can be switched to work in Big Endian mode. This leads to 4 major Big- Little Endian combinations in one system:

- Little Endian CPU with TCP220 (Little Endian) and IP module (Big Endian)
- Little Endian CPU with TCP220 (Big Endian) and IP module (Big Endian)
- Big Endian CPU with TCP220 (Big Endian) and IP module (Big Endian)
- Big Endian CPU with TCP220 (Little Endian) and IP module (Big Endian)

See the next four subchapters for a detailed view on these combinations.

3.4.1 Intel CPU View

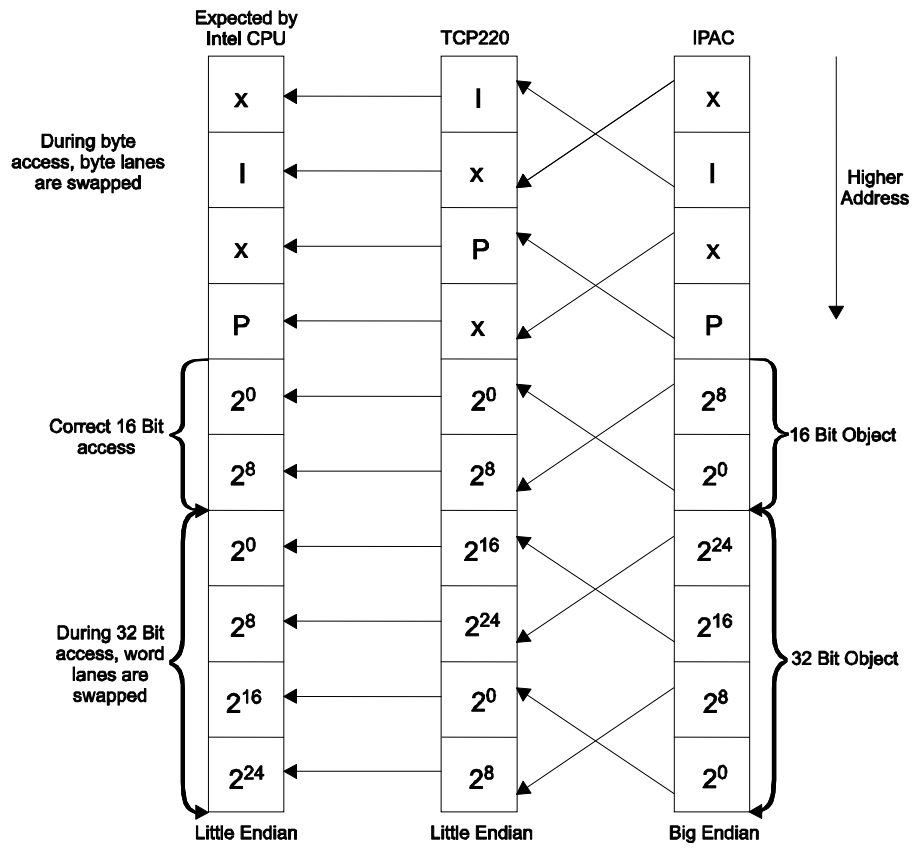

Figure 3-4 : Intel CPU View

3.4.2 PowerPC CPU View

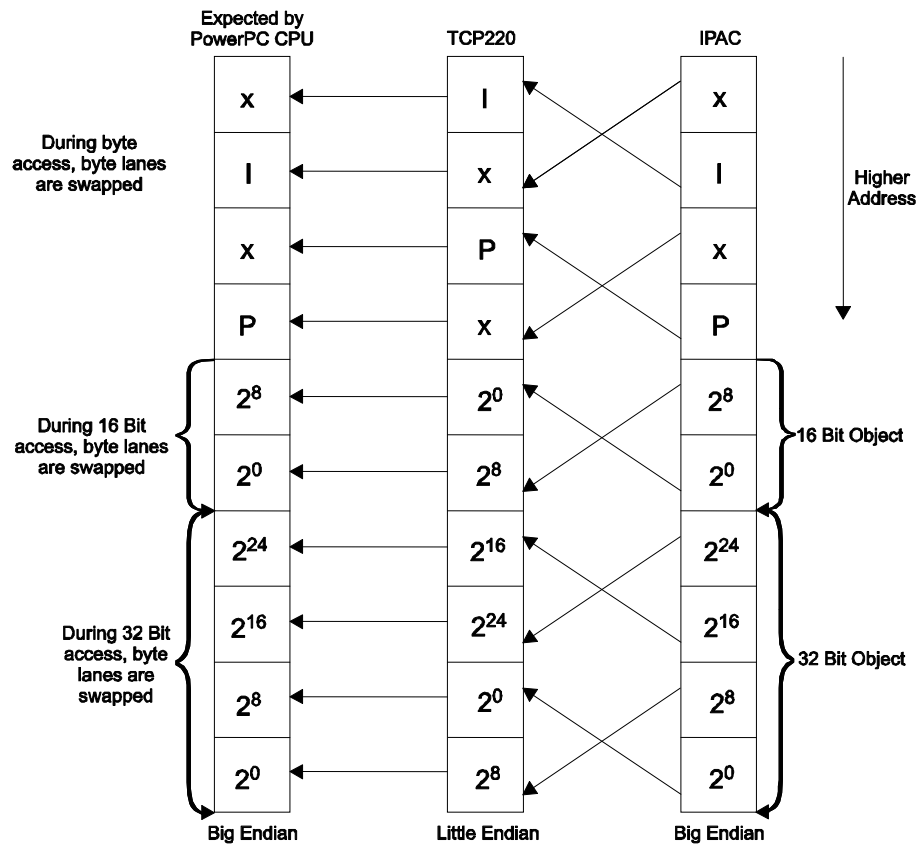

Figure 3-5 : PowerPC CPU View

3.4.3 Intel CPU View with TCP220 switched to Big Endian

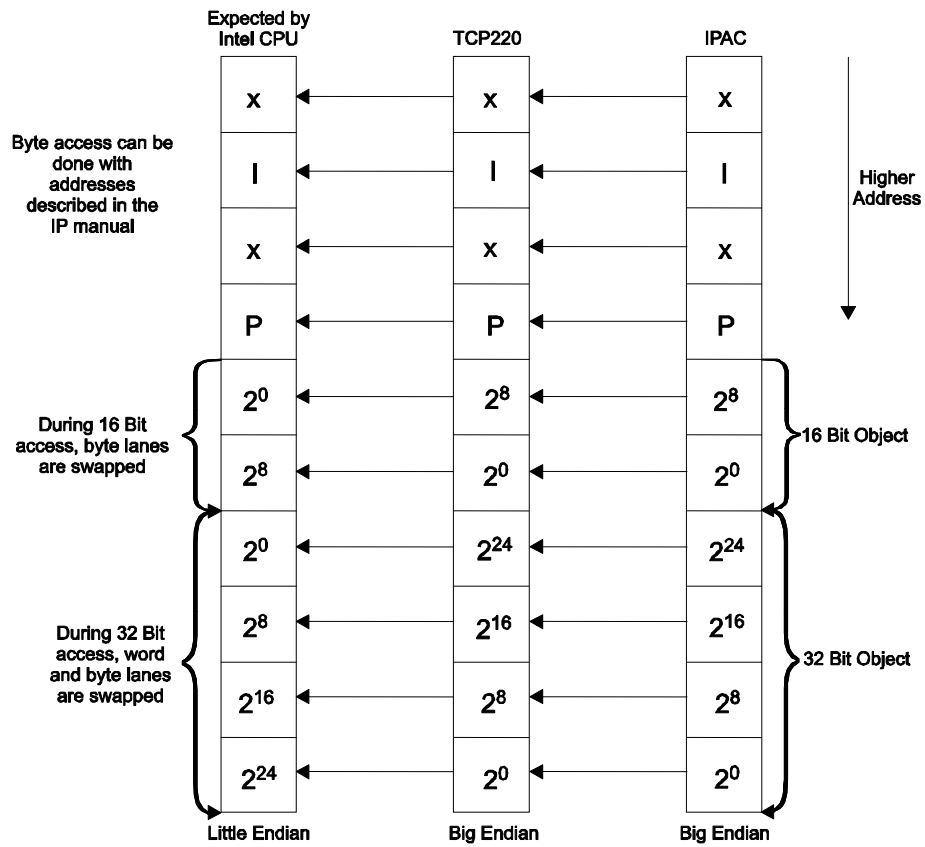

Figure 3-6 : Intel CPU View with TCP220 switched to Big Endian

3.4.4 PowerPC CPU View with TCP220 switched to Big Endian

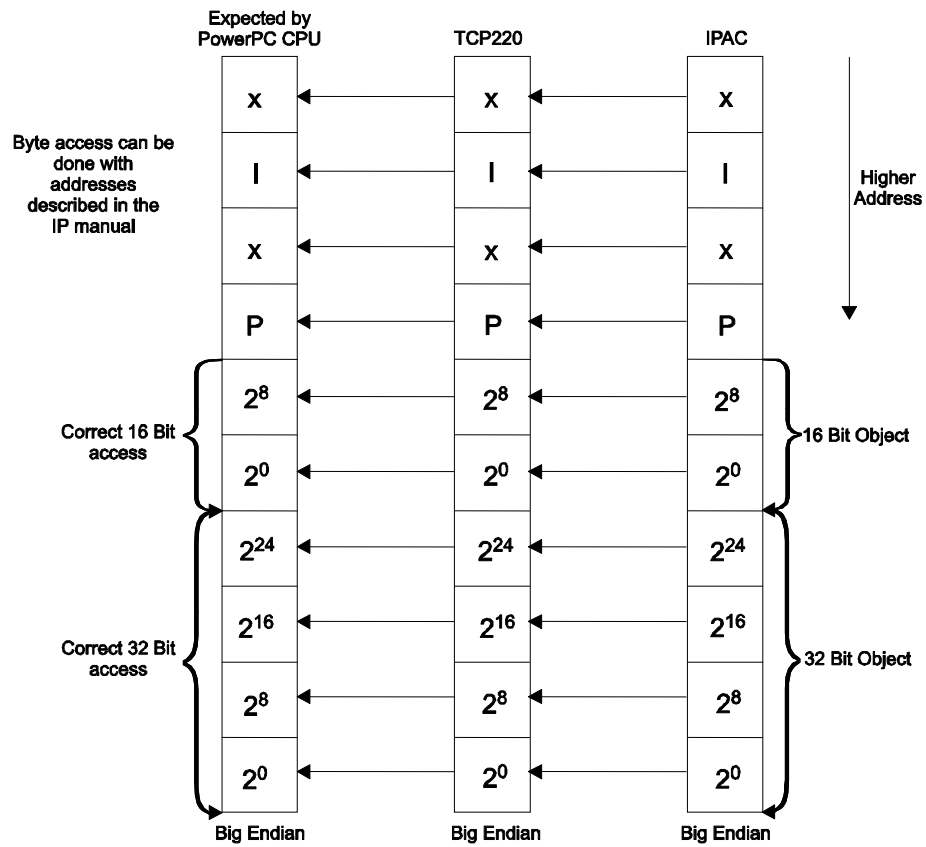

Figure 3-7 : PowerPC CPU View with TCP220 switched to Big Endian

3.5 Big / Little Endian Mode setting

The PCI target chip of the TCP220, the PCI9030 can be set to convert to Big Endian data ordering on the local bus. This is useful for IP modules that use Big Endian byte ordering. Big Endian byte ordering is the convention used in the Motorola 68000 microprocessor family and is the VMEbus convention.

Changing Local Space 0, 1 or 2 to Big Endian mode results in swapped data lines of the local bus:

A 32 bit access is separated by the PCI9030 into two local 16 bit accesses. Byte lane 0 and 1 are swapped, and byte lane 2 and 3 are swapped.

During 16 bit access, the upper and lower bytes are displayed in reverse order.

During 8 bit access odd and even addresses are swapped. To access Address 0x00, the Address 0x01 must be used. An access to Address 0x01 is done by Address 0x00.

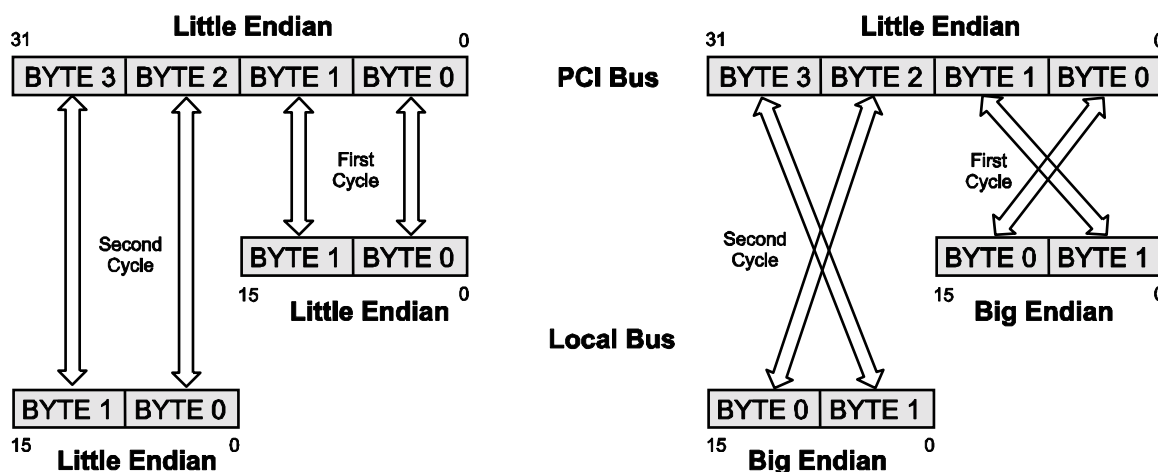

Figure 3-8 : PCI to Local Byte lane swapping

The local Endian mode of the PCI9030 can be changed for each local space separately. This is done by changing the value of bit 24 in the corresponding Bus Region Descriptor Register:

To change local Space 0, that provides access to the local control and status registers, from Little Endian to Big Endian mode, write 0xD5 to PCI BAR0 + 0x2B.

To change local Space 1, that provides access to IP I/O- ID and INT- Space, from Little Endian to Big Endian mode, write 0x15 to PCI BAR0 + 0x2F.

To change local Space 2, that provides access to the IP MEM-Space (16 bit port), from Little Endian to Big Endian mode, write 0x15 to PCI BAR0 + 0x33.

Changing local Space 3 from Little Endian to Big Endian mode has no effect, because this space has only an 8 bit port.

4 IP Interface

The IP FPGA provides the interface between the PCI9030 local bus and the IP slots.

The IP FPGA also provides the IP Interface Control Registers.

A PCI access to the TCP220 will be terminated in every case. If the IP does not generate an ACK#, a local timeout will terminate the IP access after a timeout time of 8 μ s and the timeout bit is set in the IP Status Register. All F's are returned for read cycles.

The IP FPGA is configured at power-up by an on board serial PROM.

4.1 PCI9030 Local Space Assignment

The PCI9030 local spaces must be used to access the IP Interface. The PCI base address for each local space can be obtained from the PCI9030 PCI configuration register space.

Space 0 contains the IP Control and Status Register.

Space 1 provides access to I/O ID and INT-Space of all IPs.

Space 2 is used for the IP A-D Memory space.

Space 3 is also used for IP A-D Memory space, but provides linear addressing for IP modules, that use only D7:0.

PCI9030 Local Space	Size (Byte)	Port Width (Bit)	Endian Mode	IP Interface Space
0	256	16	Little	IP Interface Register
1	1K	16	Little	IP A-D ID, INT, I/O Space
2	32M	16	Little	IP A-D MEM Space (16 bit)
3	16M	8	Little	IP A-D MEM Space (8 bit)

Figure 4-1 : PCI9030 Local Space Assignment

4.1.1 Local Space 0 Address Map

The PCI9030 local space 0 is used for the IP Interface Registers.

The PCI base address for local space 0 can be obtained from the PCIBAR2 Register at offset 0x18 in the PCI9030 PCI configuration register space.

PCI Base Address 2 +	Size(Byte)	Register
0x00	2	REVISION ID
0x02	2	IP A CONTROL
0x04	2	IP B CONTROL
0x06	2	IP C CONTROL
0x08	2	IP D CONTROL
0x0A	2	RESET
0x0C	2	STATUS
0x0E	2	Reserved
0x10 - 0xFF	240	Reserved

Figure 4-2 : Local Space 0 Address Map

4.1.2 Local Space 1 Address Map

The PCI9030 local space 1 is used for the IP A-D ID, INT and I/O space.

The PCI base address for local space 1 can be obtained from the PCIBAR3 Register at offset 0x1C in the PCI9030 PCI configuration register space.

PCI Base Address 3 +		Size (Byte)	Description
Start	End		
0x0000_0000	0x0000_007F	128	IP A I/O Space
0x0000_0080	0x0000_00BF	64	IP A ID Space
0x0000_00C0	0x0000_00FF	64	IP A INT Space
0x0000_0100	0x0000_017F	128	IP B I/O Space
0x0000_0180	0x0000_01BF	64	IP B ID Space
0x0000_01C0	0x0000_01FF	64	IP B INT Space
0x0000_0200	0x0000_027F	128	IP C I/O Space
0x0000_0280	0x0000_02BF	64	IP C ID Space
0x0000_02C0	0x0000_02FF	64	IP C INT Space
0x0000_0300	0x0000_037F	128	IP D I/O Space
0x0000_0380	0x0000_03BF	64	IP D ID Space
0x0000_03C0	0x0000_03FF	64	IP D INT Space

Figure 4-3 : Local Space 1 Address Map (IP A-D ID, INT, I/O Space)

The TCP220 supports read and write cycles to the IP I/O space.

The TCP220 supports read and write cycles to the IP ID space. A PCI access to the TCP220 will be terminated in every case. If the IP supports write access to its ID space, data will be written to the ID-PROM. If the IP does not support write access to its ID space, no ACK# will be generated by the IP to the local control logic, and a local timeout will terminate the IP write cycle after a timeout time of 8µs and the timeout bit is set in the IP Status Register.

The TCP220 supports read and write cycles to the IP INT space. A read access to the IP INT space initiates an IP interrupt acknowledge cycle. A read access with address A1=0 (i.e. 0x0000_00c0) initiates an interrupt acknowledge cycle for IP INT0#, a read access with address A1=1 (i.e. 0x0000_00c2) initiates an interrupt acknowledge cycle for IP INT1#. The read access returns the interrupt vector. This feature is helpful for IP modules that require an interrupt acknowledge cycle to remove their pending interrupt request. If the IP does not support write access to its INT space, no ACK# will be generated by the IP, and a local timeout will terminate the cycle after a timeout time of 8µs and the timeout bit is set in the IP Status Register.

4.1.3 Local Space 2 Address Map

The PCI9030 local space 2 is used for the IP A-D Memory space (16 bit port). IPs with Memory space that uses D7:0 only, should be accessed via Local Space 3. See section below for details.

The PCI base address for local space 2 can be obtained from the PCIBAR4 Register at offset 0x20 in the PCI9030 PCI configuration register space.

PCI Base Address 4 +		Size (Byte)	Description
Start	End		
0x0000_0000	0x007F_FFFF	8M	IP A MEM Space (16 bit)
0x0080_0000	0x00FF_FFFF	8M	IP B MEM Space (16 bit)
0x0100_0000	0x017F_FFFF	8M	IP C MEM Space (16 bit)
0x0180_0000	0x01FF_FFFF	8M	IP D MEM Space (16 bit)

Figure 4-4 : Local Space 2 Address Map (IP A-D Memory Space 16 bit)

4.1.4 Local Space 3 Address Map

The PCI9030 local space 3 is used for the IP A-D Memory space (8 bit port). This space allows linear addressing of the IP memory space for IP's with 8 bit port width (D0-D7) only.

The PCI base address for local space 3 can be obtained from the PCIBAR5 Register at offset 0x24 in the PCI9030 PCI configuration register space.

Offset (Base = PCI Base Address 5)		Size (Byte)	Description
Start	End		
0x0000_0000	0x003F_FFFF	4M	IP A MEM Space (8 bit)
0x0040_0000	0x007F_FFFF	4M	IP B MEM Space (8 bit)
0x0080_0000	0x00BF_FFFF	4M	IP C MEM Space (8 bit)
0x00C0_0000	0x00FF_FFFF	4M	IP D MEM Space (8 bit)

Figure 4-5 : Local Space 3 Address Map (IP A-D Memory Space 8 bit)

4.2 IP Interface Register

4.2.1 Revision ID Register

The Revision ID Register shows the revision of the on board IP FPGA logic. Initial Value is 0x00.

Changes in the on board FPGA logic will be signed by incrementing the register value.

Bit	Name	Description
15 (MSB)	-	Read: Always 0 Write: No Effect
14	-	
13	-	
12	-	
11	-	
10	-	
9	-	
8	-	
7	REV_ID	Read: FPGA Logic Revision ID Write: No Effect
6		
5		
4		
3		
2		
1		
0 (LSB)		

Figure 4-6 : Revision ID Register (PCI Base Address 2 + 0x00)

4.2.2 IP Control Register

The IP Control Registers can be used to control IP interrupts, recover time and clock rate. Each IP has its own IP Control Register. After power-up or board reset, all bits in the IP Control Register are cleared (0).

Each IP interrupt can be enabled or disabled separately. Interrupt detection can be switched between level and edge sensitive. Edge sensitive interrupts must be cleared by a write to the corresponding bit in the IP Status Register.

If the ERR_INT_EN bit is set to "1", an active IP ERROR# line will generate an interrupt. This interrupt can be cleared by setting the ERR_INT_EN bit of the corresponding IP to "0".

The status of the IP ERROR# line can be read from the IP Status Register.

If the TIME_INT_EN bit is set to "1" and an IP timeout occurs, the TCP220 will generate an interrupt. This interrupt can be cleared by writing '1' to the corresponding IP Timeout Status bit in the IP Status Register.

If IP recover time is enabled for an IP slot, an IP cycle for this slot will not begin until the IP recover time is expired. The IP recover time is app. 1µs.

IP Clock Rate can be selected between 8 MHz and 32 MHz for each IP separately. After power-up or board reset, the Clock Rate is set to 8 MHz for all IPs.

Bit	Name	Description
15 (MSB)	-	Read: Always 0 Write: No effect, should be written with 0's
14	-	
13	-	
12	-	
11	-	
10	-	
9	-	
8	-	
7	INT1_EN	0 : IP A interrupt 1 disabled 1 : IP A interrupt 1 enabled
6	INT0_EN	0 : IP A interrupt 0 disabled 1 : IP A interrupt 0 enabled
5	INT1_SENSE	0 : IP A interrupt 1 level sensitive 1 : IP A interrupt 1 edge sensitive
4	INT0_SENSE	0 : IP A interrupt 0 level sensitive 1 : IP A interrupt 0 edge sensitive
3	ERR_INT_EN	0 : IP A error interrupt disabled 1 : IP A error interrupt enabled
2	TIME_INT_EN	0 : IP A timeout interrupt disabled 1 : IP A timeout interrupt enabled
1	RECOVER	0 : IP A recover time disabled 1 : IP A recover time enabled
0 (LSB)	CLKRATE	0 : IP A clock rate 8 MHz 1 : IP A clock rate 32 MHz

Figure 4-7 : IP A Control Register (PCI Base Address 2 + 0x02)

Bit	Name	Description
15 (MSB)	-	Read : Always 0 Write: No effect, should be written with 0's
14	-	
13	-	
12	-	
11	-	
10	-	
9	-	
8	-	
7	INT1_EN	0 : IP B interrupt 1 disabled 1 : IP B interrupt 1 enabled
6	INT0_EN	0 : IP B interrupt 0 disabled 1 : IP B interrupt 0 enabled
5	INT1_SENSE	0 : IP B interrupt 1 level sensitive 1 : IP B interrupt 1 edge sensitive
4	INT0_SENSE	0 : IP B interrupt 0 level sensitive 1 : IP B interrupt 0 edge sensitive
3	ERR_INT_EN	0 : IP B error interrupt disabled 1 : IP B error interrupt enabled
2	TIME_INT_EN	0 : IP B timeout interrupt disabled 1 : IP B timeout interrupt enabled
1	RECOVER	0 : IP B recover time disabled 1 : IP B recover time enabled
0 (LSB)	CLKRATE	0 : IP B clock Rate 8 MHz 1 : IP B clock Rate 32 MHz

Figure 4-8 : IP B Control Register (PCI Base Address 2 + 0x04)

Bit	Name	Description
15 (MSB)	-	Read: Always 0 Write: No effect, should be written with 0's
14	-	
13	-	
12	-	
11	-	
10	-	
9	-	
8	-	
7	INT1_EN	0 : IP C interrupt 1 disabled 1 : IP C interrupt 1 enabled
6	INT0_EN	0 : IP C interrupt 0 disabled 1 : IP C interrupt 0 enabled
5	INT1_SENSE	0 : IP C interrupt 1 level sensitive 1 : IP C interrupt 1 edge sensitive
4	INT0_SENSE	0 : IP C interrupt 0 level sensitive 1 : IP C interrupt 0 edge sensitive
3	ERR_INT_EN	0 : IP C error interrupt disabled 1 : IP C error interrupt enabled
2	TIME_INT_EN	0 : IP C timeout interrupt disabled 1 : IP C timeout interrupt enabled
1	RECOVER	0 : IP C recover time disabled 1 : IP C recover time enabled
0 (LSB)	CLKRATE	0 : IP C clock rate 8 MHz 1 : IP C clock rate 32 MHz

Figure 4-9 : IP C Control Register (PCI Base Address 2 +0x06)

Bit	Name	Description
15 (MSB)	-	Read: Always 0 Write: No effect, should be written with 0's
14	-	
13	-	
12	-	
11	-	
10	-	
9	-	
8	-	
7	INT1_EN	0 : IP D interrupt 1 disabled 1 : IP D interrupt 1 enabled
6	INT0_EN	0 : IP D interrupt 0 disabled 1 : IP D interrupt 0 enabled
5	INT1_SENSE	0 : IP D interrupt 1 level sensitive 1 : IP D interrupt 1 edge sensitive
4	INT0_SENSE	0 : IP D interrupt 0 level sensitive 1 : IP D interrupt 0 edge sensitive
3	ERR_INT_EN	0 : IP D error interrupt disabled 1 : IP D error interrupt enabled
2	TIME_INT_EN	0 : IP D timeout interrupt disabled 1 : IP D timeout interrupt enabled
1	RECOVER	0 : IP D recover time disabled 1 : IP D recover time enabled
0 (LSB)	CLKRATE	0 : IP D clock rate 8 MHz 1 : IP D clock rate 32 MHz

Figure 4-10: IP D Control Register (PCI Base Address 2 + 0x08)

4.2.3 IP Reset Register

The IP Reset Register can be used to initiate an IP RESET cycle and to detect when the IP RESET cycle has finished. Each IP RESET# signal can be asserted separately.

Writing a 1 to bit 3, 2, 1, or 0 of the IP Reset Register initiates that the reset cycle and the corresponding IP RESET# signal is asserted. After 200 ms, the on board logic automatically negates the IP RESET# signal and completes the IP Reset cycle.

The IP Reset Register can be read to verify the IP Reset status.

At power-up or board reset, all IP RESET# signals are asserted simultaneously.

Bit	Name	Description	
15 (MSB)	-	Read: Always 0 Write: No effect, should be written with 0's.	
14	-		
13	-		
12	-		
11	-		
10	-		
9	-		
8	-		
7	-		
6	-		
5	-		
4	-		
3	IPD_RESET		Read: 0 : IP RESET# - signal is de-asserted 1 : IP RESET# - signal is asserted Write: 0 : No effect 1 : Assert corresponding IP RESET# - signal (automatic negation after 200 ms)
2	IPC_RESET		
1	IPB_RESET		
0 (LSB)	IPA_RESET		

Figure 4-11: IP Reset Register (PCI Base Address 2 + 0x0A)

4.2.4 IP Status Register

The IP Status Register can be used to read IP timeout, error and interrupt status.

An IP timeout occurs if the IP module fails to generate the IP ACK# signal within the IP timeout time. The IP timeout time is app. 8µs. An IP timeout is not reported to the PCI9030 or the PCI master, but in the IP Status Register. If the corresponding IP_TIME_EN bit in the IP Control Register is set, an interrupt is generated if a timeout occurs. This interrupt can be cleared by writing '1' to the timeout status bit. If a timeout occurs during an IP read, all ones (0xFF) are returned.

The IP ERROR# signal is used to indicate component failure, unrecoverable self-test failures or serious, hard-wired configuration errors. The status of the IP ERROR# signals can be read in the IP Status Register.

Interrupt status of all IP interrupt lines can read in the IP Status Register. If edge sensitive interrupt is enabled (see IP Control Register for detail) and an interrupt is active, writing a "1" to bit 7:0 clears the corresponding interrupt status.

Bit	Name	Description
15 (MSB)	TIME_D	Read : 0 : IP_D timeout has not occurred 1 : IP_D timeout has occurred Write : 0 : No effect 1 : Clear IP_D timeout status
14	TIME_C	Read : 0 : IP_C timeout has not occurred 1 : IP_C timeout has occurred Write : 0 : No effect 1 : Clear IP_C timeout status
13	TIME_B	Read : 0 : IP_B timeout has not occurred 1 : IP_B timeout has occurred Write : 0 : No effect 1 : Clear IP_B timeout status
12	TIME_A	Read : 0 : IP_A timeout has not occurred 1 : IP_A timeout has occurred Write : 0 : No effect 1 : Clear IP_A timeout status
11	ERR_D	Read : 0 : IP_D ERROR# signal de-asserted 1 : IP_D ERROR# signal asserted Write : 0 : No effect 1 : No effect
10	ERR_C	Read : 0 : IP_C ERROR# signal de-asserted 1 : IP_C ERROR# signal asserted Write : 0 : No effect 1 : No effect
9	ERR_B	Read : 0 : IP_B ERROR# signal de-asserted 1 : IP_B ERROR# signal asserted Write : 0 : No effect 1 : No effect
8	ERR_A	Read : 0 : IP_A ERROR# signal de-asserted 1 : IP_A ERROR# signal asserted Write : 0 : No effect 1 : No effect
7	INT1_D	Read : 0 : No IP_D interrupt 1 request 1 : Active IP_D interrupt 1 request Write : 0 : No effect 1 : Clear edge sensitive IP_D interrupt 1 status
6	INT0_D	Read : 0 : No IP_D interrupt 0 request 1 : Active IP_D interrupt 0 request Write : 0 : No effect 1 : Clear edge sensitive IP_D interrupt 0 status
5	INT1_C	Read : 0 : No IP_C interrupt 1 request 1 : Active IP_C interrupt 1 request Write : 0 : No effect 1 : Clear edge sensitive IP_C interrupt 1 status

Bit	Name	Description
4	INT0_C	Read : 0 : No IP_C interrupt 0 request 1 : Active IP_C interrupt 0 request Write : 0 : No effect 1 : Clear edge sensitive IP_C interrupt 0 status
3	INT1_B	Read : 0 : No IP_B interrupt 1 request 1 : Active IP_B interrupt 1 request Write : 0 : No effect 1 : Clear edge sensitive IP_B interrupt 1 status
2	INT0_B	Read : 0 : No IP_B interrupt 0 request 1 : Active IP_B interrupt 0 request Write : 0 : No effect 1 : Clear edge sensitive IP_B interrupt 0 status
1	INT1_A	Read : 0 : No IP_A interrupt 1 request 1 : Active IP_A interrupt 1 request Write : 0 : No effect 1 : Clear edge sensitive IP_A interrupt 1 status
0 (LSB)	INT0_A	Read : 0 : No IP_A interrupt 0 request 1 : Active IP_A interrupt 0 request Write : 0 : No effect 1 : Clear edge sensitive IP_A interrupt 0 status

Figure 4-12: IP Status Register (PCI Base Address 2 + 0x0C)

4.3 IP Interrupts

All IP interface interrupt sources (Timeout, Error, IP A-D INT0, IP A-D INT1) are mapped to PCI interrupt INTA#.

For quick interrupt source detection, the IP Status Register can be read to determine the IP interrupt source.

Level sensitive IP interrupts, which are most common for IP modules are cleared by either an interrupt acknowledge cycle to the IP or by accessing an Interrupt Status Register on the IP module.

A read access to the IP INT space initiates an IP interrupt acknowledge cycle. A read access with address A1=0 (i.e. 0x0000_00c0) initiates an interrupt acknowledge cycle for IP INT0#, a read access with address A1=1 (i.e. 0x0000_00c2) initiates an interrupt acknowledge cycle for IP INT1#. The read access returns the interrupt vector. This feature is helpful for IP modules that require an interrupt acknowledge cycle to remove their pending interrupt request.

Timeout interrupts and edge sensitive IP interrupts must be cleared in the IP Status Register.

IP Error interrupts must be cleared in the corresponding IP Control Register.

5 IP Strobe Signal

The IP strobe signal is an uncommitted line of the IP logic interface, which may be used as an optional input to or output from an IP module. It is reserved for a digital strobe or clock signal related to the functionality of the IP.

Strobe signals of all IP slots are accessible on the TCP220 via a 4-pin jumper field.

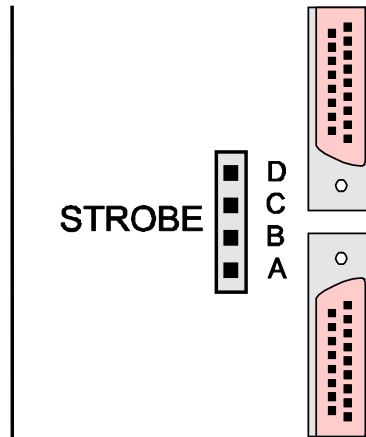

Figure 5-1 : IP Strobe Signal

6 Installation of IndustryPacks

Before installing an IndustryPack, be sure that the power supply for the TCP220 is turned off.

The component is an Electrostatic Sensitive Device (ESD). Use an anti-static mat connected to a wristband when handling or installing the components.

Installing IndustryPacks on the TCP220 is done by simply snapping them into one of the four IP slots. The connectors are keyed, so the IndustryPack can only be installed correctly.

After an IP has been installed it can be secured on the carrier board. This is normally necessary only in high vibration or shock environments.

Screws and spacers are required to fix a single IP on the TCP220. They can be ordered from TEWS TECHNOLOGIES (Part number: TIPxxx-HK).

The I/O Lines of all IPs are routed to Compact PCI J4 and J5. The routing is PICMG 2.4 R1.0 compliant.

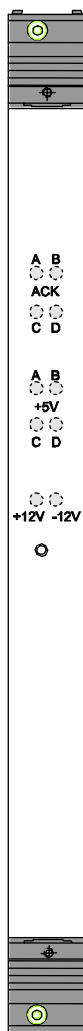

Figure 6-1 : TCP220 front view

7 Indicators

7.1 ACK- and Power- LEDs

For a quick visual inspection the TCP220 offers 10 LEDs in the front panel.

Each IndustryPack has its own "ACK"-LED, which is lit for about 200ms whenever an access to the corresponding IP happens.

Function	Label	Color	Description
IP A ACK	A	green	Indicates access to IP A
IP B ACK	B	green	Indicates access to IP B
IP C ACK	C	green	Indicates access to IP C
IP D ACK	D	green	Indicates access to IP D

Figure 7-1 : IP ACK LED

Additionally there are 6 green Power-LEDs on the TCP220:

Function	Label	Color	Description
IP A +5V	+5V A	green	LED = "on": IP power supply ok
IP B +5V	+5V B	green	
IP C +5V	+5V C	green	
IP D +5V	+5V D	green	
+12V common to all IP	+12V	green	LED = "on": +12V power ok
-12V common to all IP	-12V	green	LED = "on": -12V power ok

Figure 7-2 : IP Power LED

7.2 Fuses and Filters

All IP slots are fuse protected. The fuses used on the TCP220 are self-healing fuses. For improved performance the TCP220 provides RF filtering and decoupling capacitors on all IP power lines.

8 Pin Assignment

8.1 IP Connectors

The table below shows the complete IP J1 logic interface pin assignments. Some of these signals are not used on the TCP220.

Pin #	Signal	Pin #	Signal	Pin #	Signal	Pin #	Signal
1	GND	2	CLK	26	GND	27	+5V
3	Reset#	4	D0	28	R/W#	29	IDSel#
5	D1	6	D2	30	DMAReq0#	31	MemSel#
7	D3	8	D4	32	DMAReq1#	33	IntSel#
9	D5	10	D6	34	DMAck#	35	IOSel#
11	D7	12	D8	36	Reserved	37	A1
13	D9	14	D10	38	DMAEnd#	39	A2
15	D11	16	D12	40	Error#	41	A3
17	D13	18	D14	42	IntReq0#	43	A4
19	D15	20	BS0#	44	IntReq1#	45	A5
21	BS1#	22	-12V	46	Strobe#	47	A6
23	+12V	24	+5V	48	ACK#	49	Reserved
25	GND			50	GND		

Figure 8-1 : IP J1 Logic Interface Pin Assignment

The pin assignment of the IP J2 I/O connector is IP specific.

8.2 Compact PCI J4

Position	Row					
	A	B	C	D	E	F
25	IO_B1	IO_B2	IO_B3	IO_B4	IO_B5	GND
24	IO_B6	IO_B7	IO_B8	IO_B9	IO_B10	GND
23	IO_B11	IO_B12	IO_B13	IO_B14	IO_B15	GND
22	IO_B16	IO_B17	IO_B18	IO_B19	IO_B20	GND
21	IO_B21	IO_B22	IO_B23	IO_B24	IO_B25	GND
20	IO_B26	IO_B27	IO_B28	IO_B29	IO_B30	GND
19	IO_B31	IO_B32	IO_B33	IO_B34	IO_B35	GND
18	IO_B36	IO_B37	IO_B38	IO_B39	IO_B40	GND
17	IO_B41	IO_B42	IO_B43	IO_B44	IO_B45	GND
16	IO_B46	IO_B47	IO_B48	IO_B49	IO_B50	GND
15	+3.3V	+3.3V	+3.3V	+5V	+5V	GND
14	key	key	key	key	key	GND
13	key	key	key	key	key	GND
12	key	key	key	key	key	GND
11	IO_A1	IO_A2	IO_A3	IO_A4	IO_A5	GND
10	IO_A6	IO_A7	IO_A8	IO_A9	IO_A10	GND
9	IO_A11	IO_A12	IO_A13	IO_A14	IO_A15	GND
8	IO_A16	IO_A17	IO_A18	IO_A19	IO_A20	GND
7	IO_A21	IO_A22	IO_A23	IO_A24	IO_A25	GND
6	IO_A26	IO_A27	IO_A28	IO_A29	IO_A30	GND
5	IO_A31	IO_A32	IO_A33	IO_A34	IO_A35	GND
4	IO_A36	IO_A37	IO_A38	IO_A39	IO_A40	GND
3	IO_A41	IO_A42	IO_A43	IO_A44	IO_A45	GND
2	IO_A46	IO_A47	IO_A48	IO_A49	IO_A50	GND
1	+3.3V	+3.3V	+3.3V	+5V	+5V	GND

Figure 8-2 : Compact PCI J4

8.3 Compact PCI J5

Position	Row					
	A	B	C	D	E	F
22	IO_D1	IO_D2	IO_D3	IO_D4	IO_D5	GND
21	IO_D6	IO_D7	IO_D8	IO_D9	IO_D10	GND
20	IO_D11	IO_D12	IO_D13	IO_D14	IO_D15	GND
19	IO_D16	IO_D17	IO_D18	IO_D19	IO_D20	GND
18	IO_D21	IO_D22	IO_D23	IO_D24	IO_D25	GND
17	IO_D26	IO_D27	IO_D28	IO_D29	IO_D30	GND
16	IO_D31	IO_D32	IO_D33	IO_D34	IO_D35	GND
15	IO_D36	IO_D37	IO_D38	IO_D39	IO_D40	GND
14	IO_D41	IO_D42	IO_D43	IO_D44	IO_D45	GND
13	IO_D46	IO_D47	IO_D48	IO_D49	IO_D50	GND
12	+3.3V	+3.3V	+3.3V	+5V	+5V	GND
11	IO_C1	IO_C2	IO_C3	IO_C4	IO_C5	GND
10	IO_C6	IO_C7	IO_C8	IO_C9	IO_C10	GND
9	IO_C11	IO_C12	IO_C13	IO_C14	IO_C15	GND
8	IO_C16	IO_C17	IO_C18	IO_C19	IO_C20	GND
7	IO_C21	IO_C22	IO_C23	IO_C24	IO_C25	GND
6	IO_C26	IO_C27	IO_C28	IO_C29	IO_C30	GND
5	IO_C31	IO_C32	IO_C33	IO_C34	IO_C35	GND
4	IO_C36	IO_C37	IO_C38	IO_C39	IO_C40	GND
3	IO_C41	IO_C42	IO_C43	IO_C44	IO_C45	GND
2	IO_C46	IO_C47	IO_C48	IO_C49	IO_C50	GND
1	+3.3V	+3.3V	+3.3V	+5V	+5V	GND

Figure 8-3 : Compact PCI J5